



waterwise

PVC FREE WATERPROOF FLOORING

SPECIFICATIONS

waterwise SELECT SERIES

- 7.5" X 54" X 8 mm 25.86 SF Per Carton
- AC4 Aluminum Oxide Wear Layer
- Unilin Locking System
- Kaindl Aqua Pro Technology
- Natural Emboss Matte Finish
- Enhanced Bevel Edge
- 30 Year Residential Warranty
- 5 Year Commercial Warranty
- Real Grain Technology 2x Unique Plank Visuals



GUNNISON

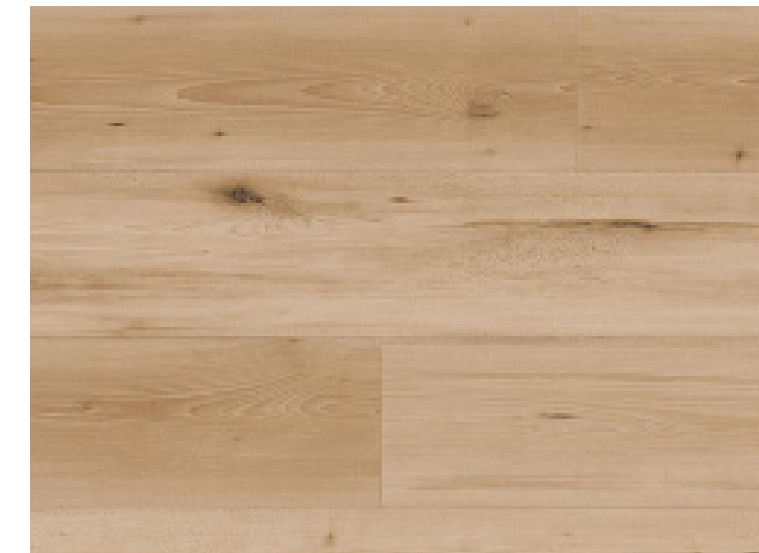

SANTA CLARA

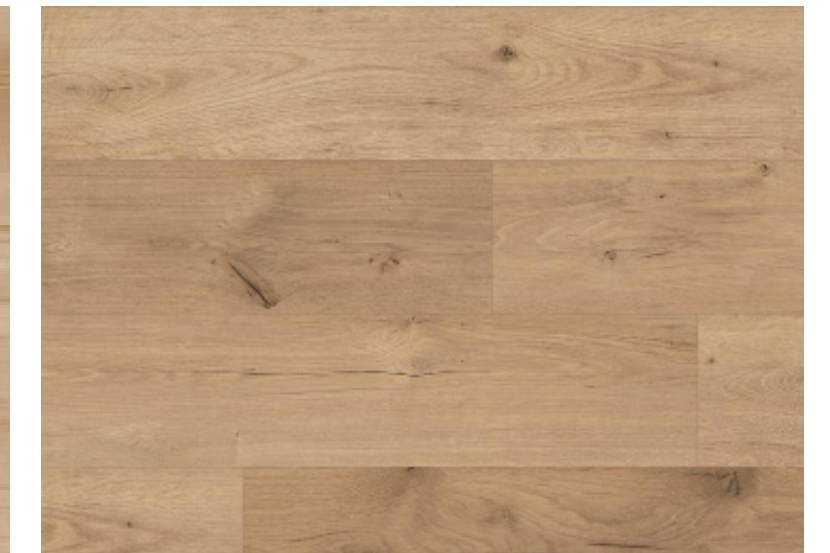

SAN JUAN

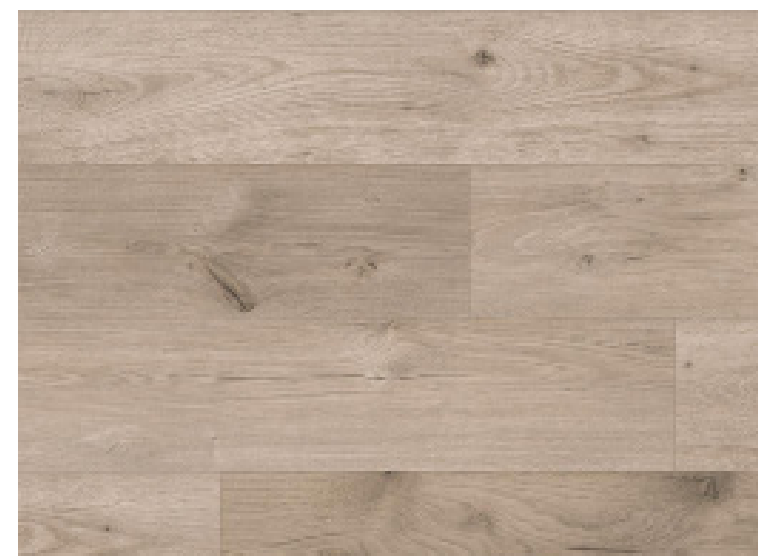

WEBER

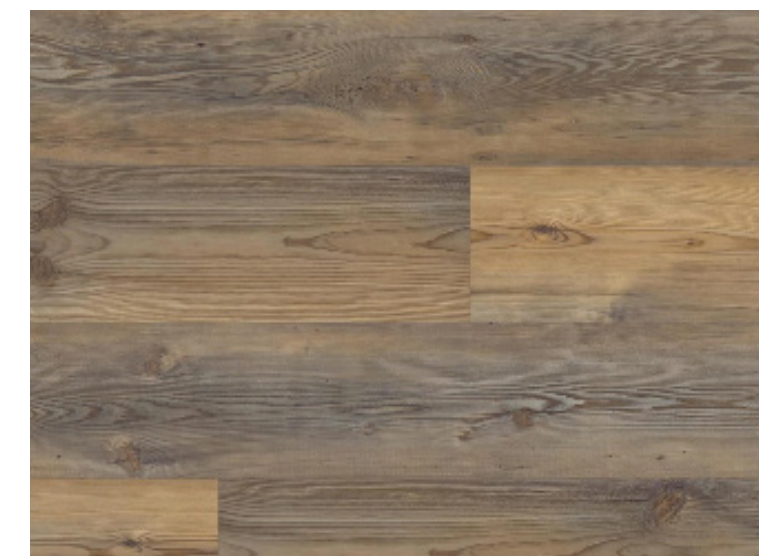

YAMPA

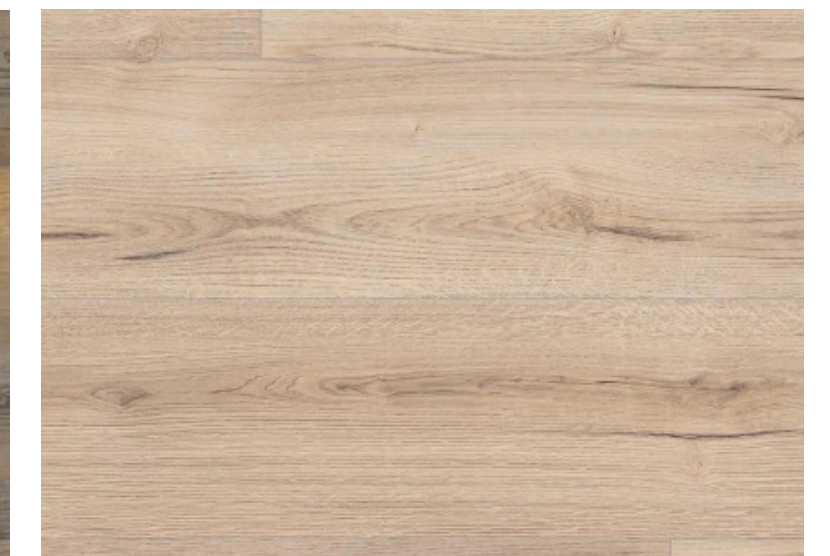

ESCALANTE

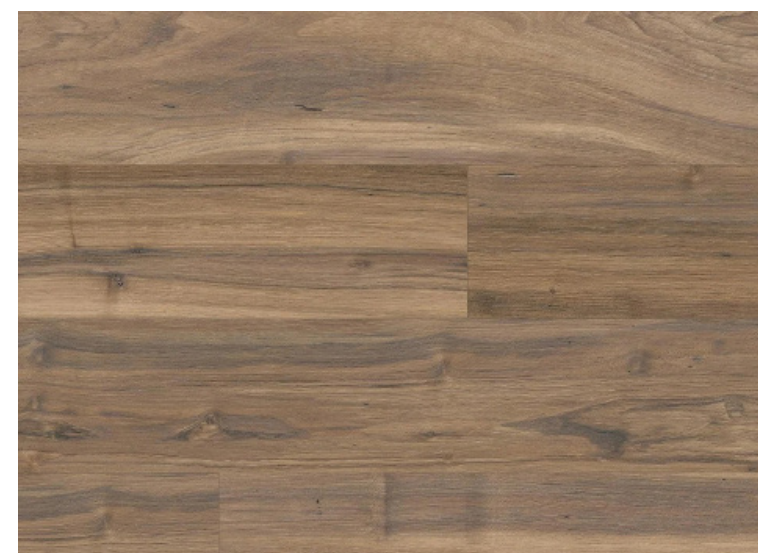

DOLORES



ALAMOSA

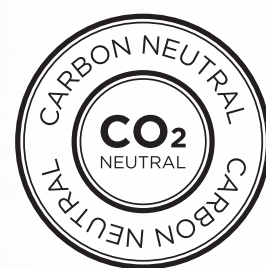

EUROPEAN
MADE

waterwise PREMIUM SERIES

- 7.5" X 54" X 10 mm 20.11 SF Per Carton
 - AC5 Aluminum Oxide Wear Layer
 - 2 MM Attached Back Pad
 - Unilin Locking System
 - Kaindl Aqua Pro Technology
 - Embossed In Register Matte Finish
 - Enhanced Bevel Edge
 - 30 Year Residential Warranty
 - 5 Year Commercial Warranty
 - Real Grain Technology 2x Unique Plank Visuals
-



PAYETTE



PORTNEUF



MADISON



GALLATIN

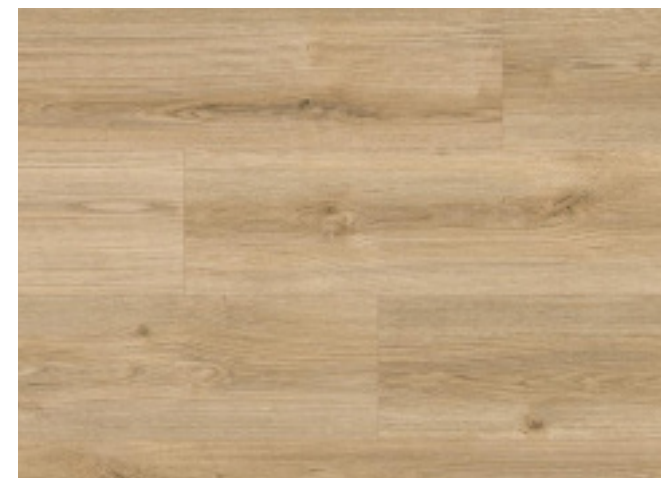

PALOUSE

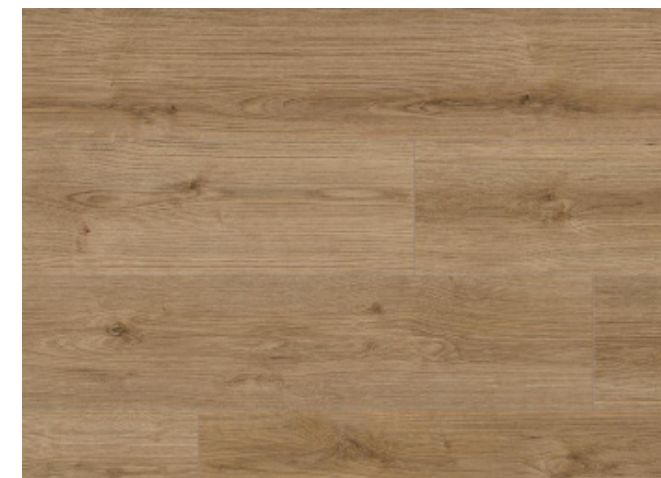

HUMBOLDT



TRUCKEE

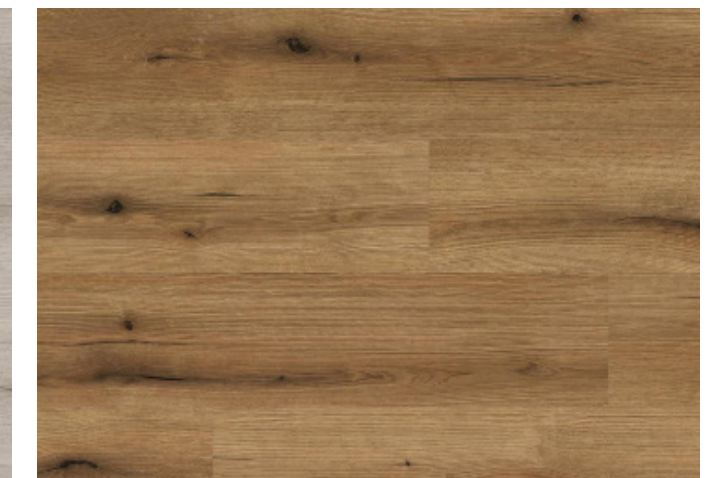

CHEHALIS



KOOTENAY

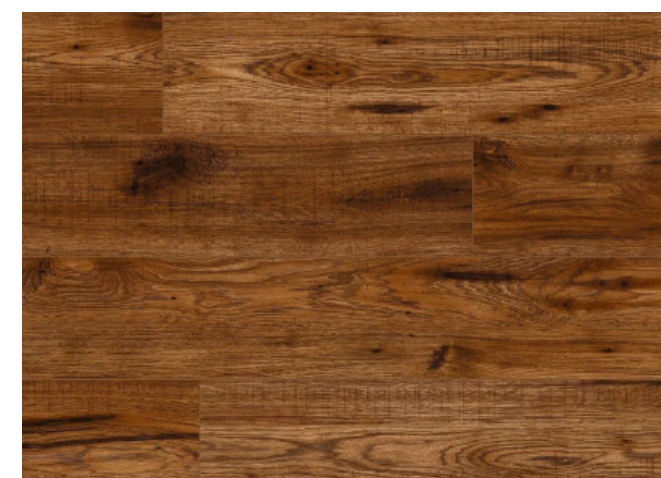

MANCOS



ANIMAS

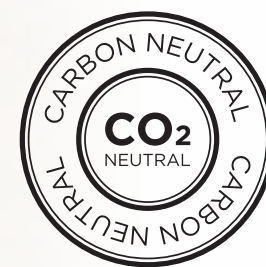
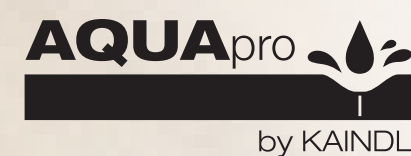

EUROPEAN
MADE

waterwise ELITE SERIES

- 9"X 78.75" X 8MM 31.69 SF Per Carton
 - AC5 Aluminum Oxide Wear Layer
 - 1 Click2GO Locking System
 - ORCA Waterproof Technology
 - Embossed In Register Matte Finish
 - Enhanced Bevel Edge
 - 30 Year Residential Warranty
 - 5 Year Commercial Warranty
 - Real Grain Technology 2x Unique Plank Visuals
-

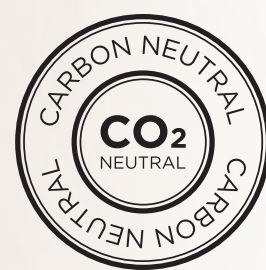

EUROPEAN
MADE

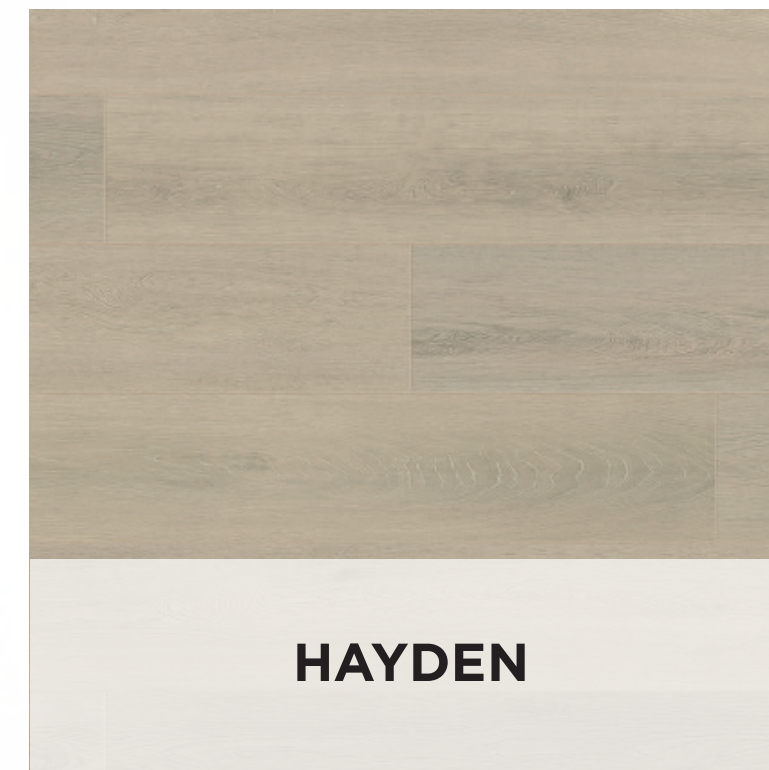

HAYDEN

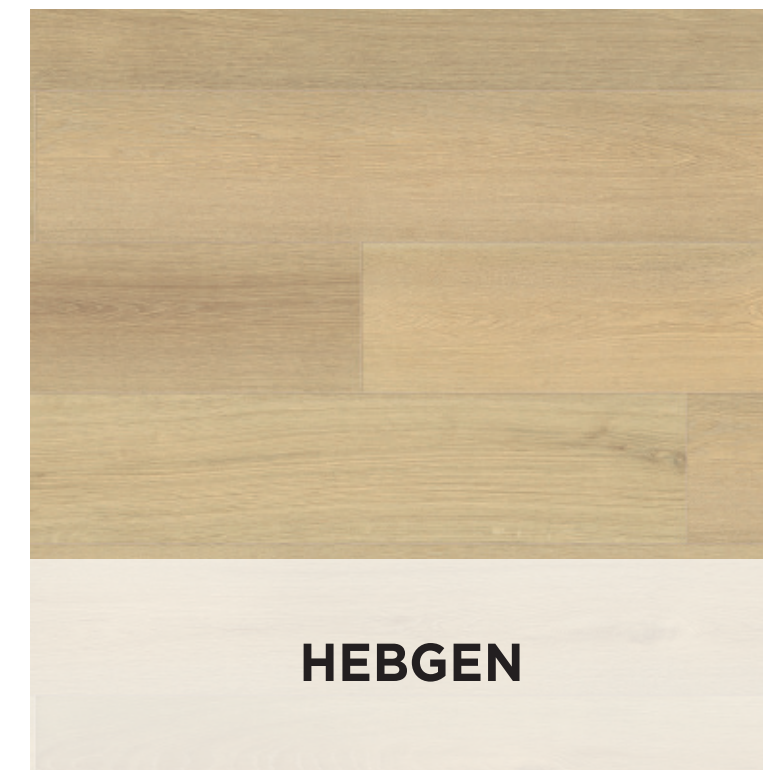

HEBGEN



JUNE

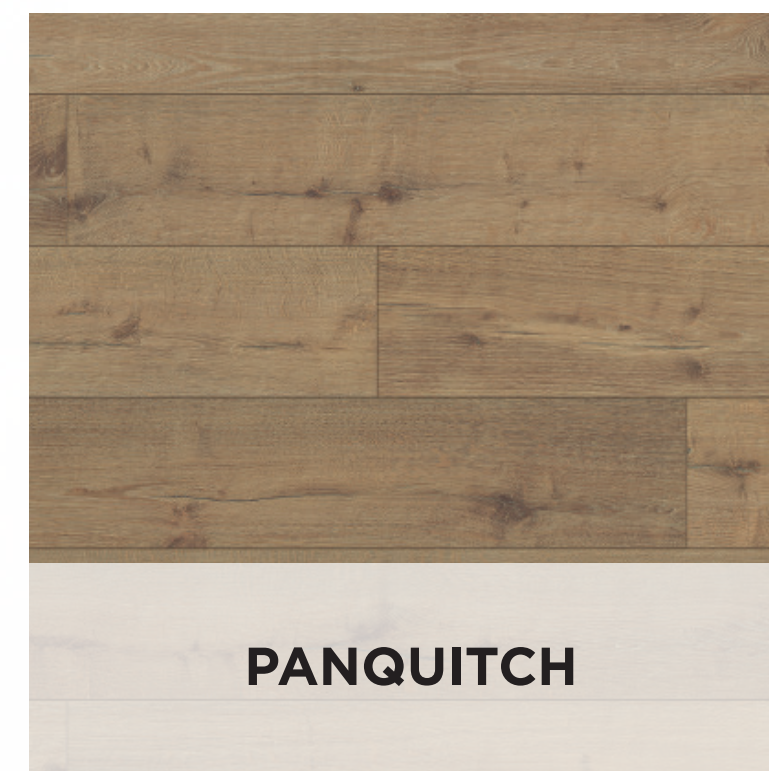

PANQUITCH

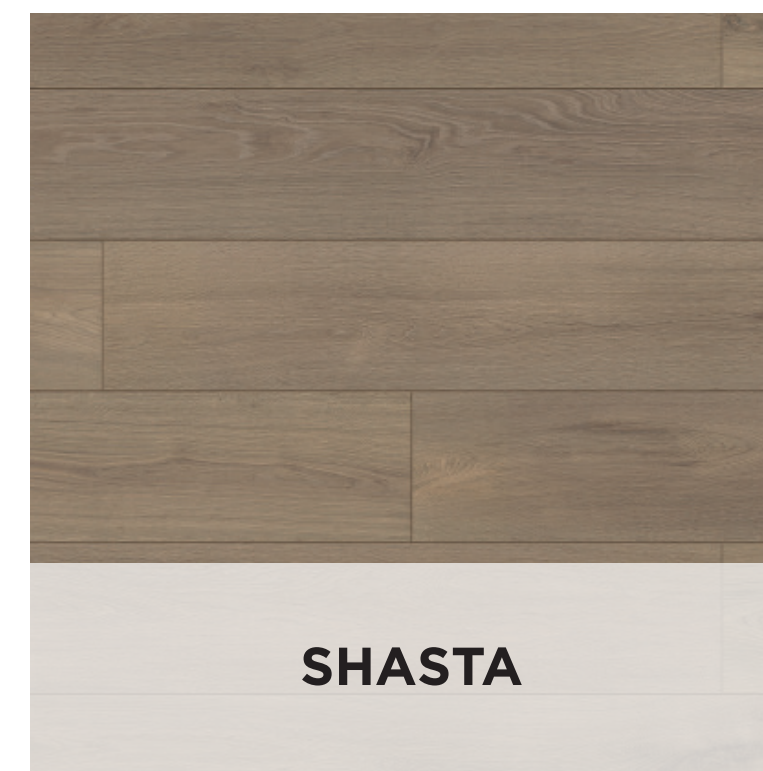

SHASTA

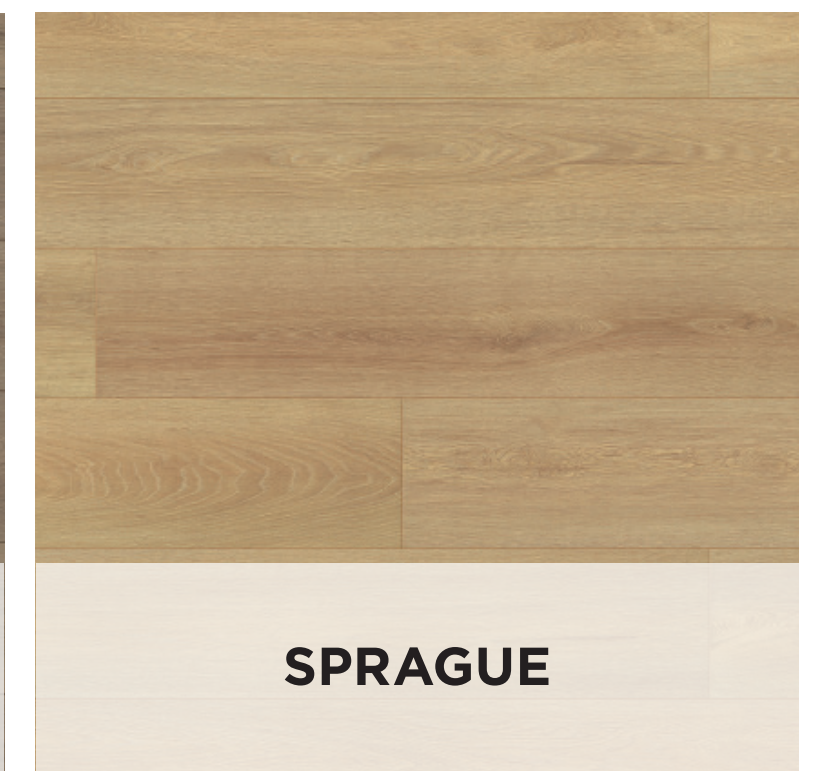

SPRAGUE

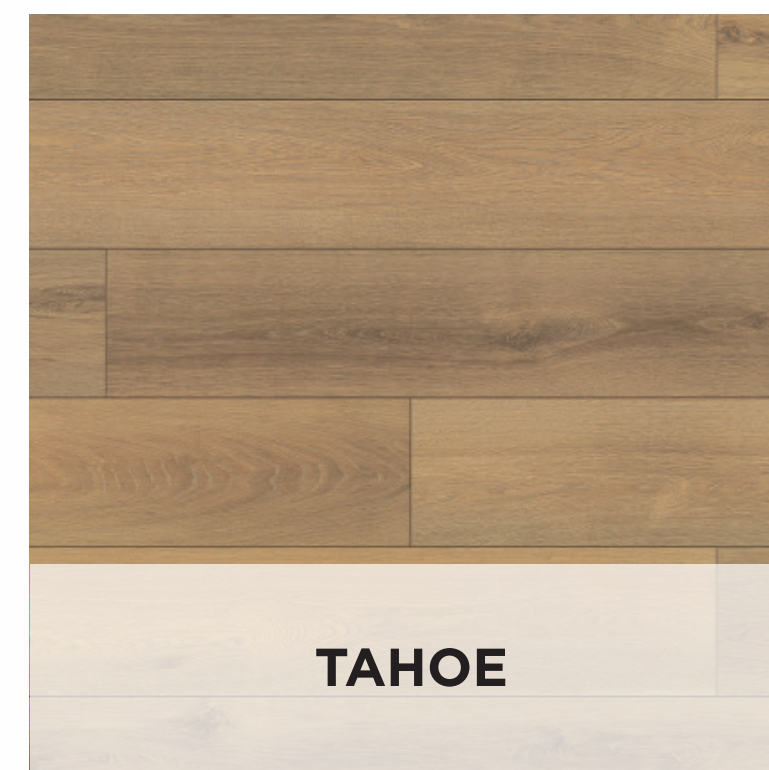

TAHOE

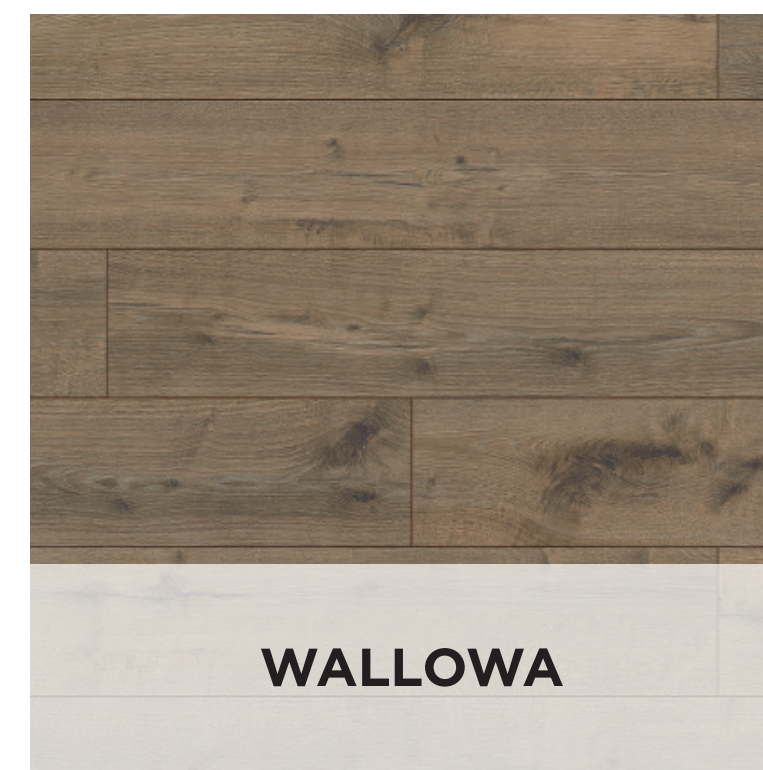

WALLOWA

waterwise TILE SERIES

- 13" X 51" X 8 mm 41.12 SF Per Carton
 - AC5 Aluminum Oxide Wear Layer
 - Unilin Locking System
 - Kaindl Aqua Pro Technology
 - Embossed In Register Matte Finish
 - Enhanced Bevel Edge
 - 30 Year Residential Warranty
 - 5 Year Commercial Warranty
 - Real Grain Technology 2x Unique Plank Visuals
-

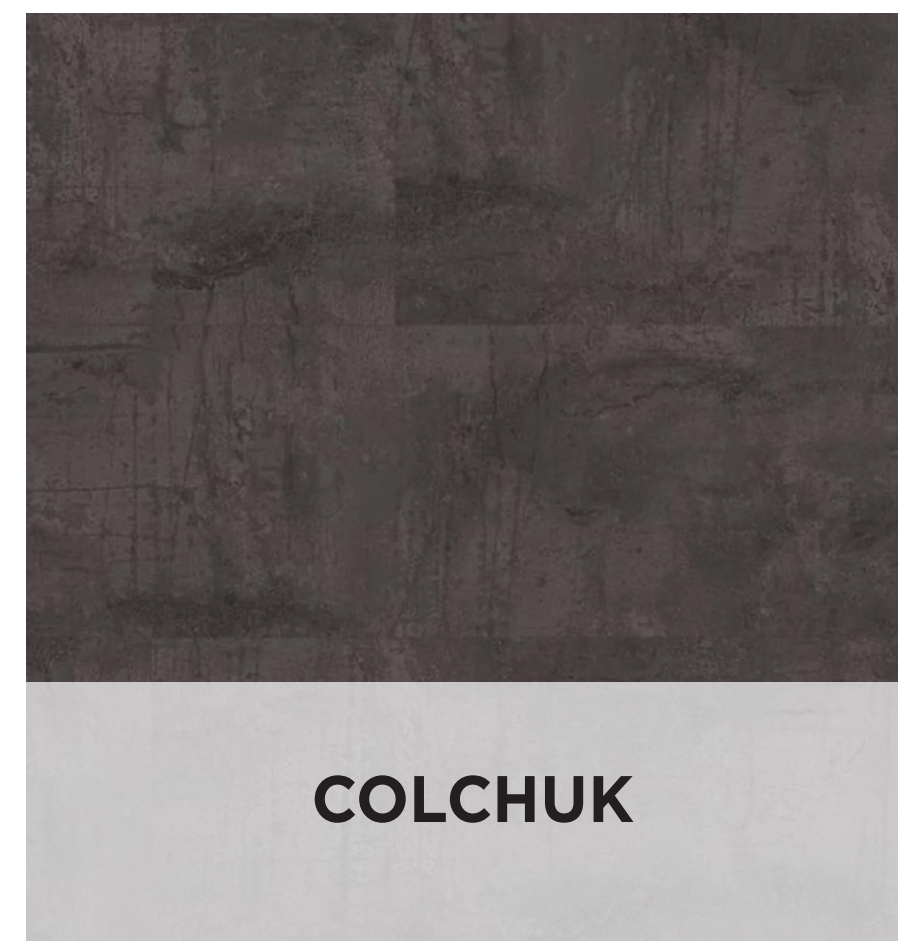
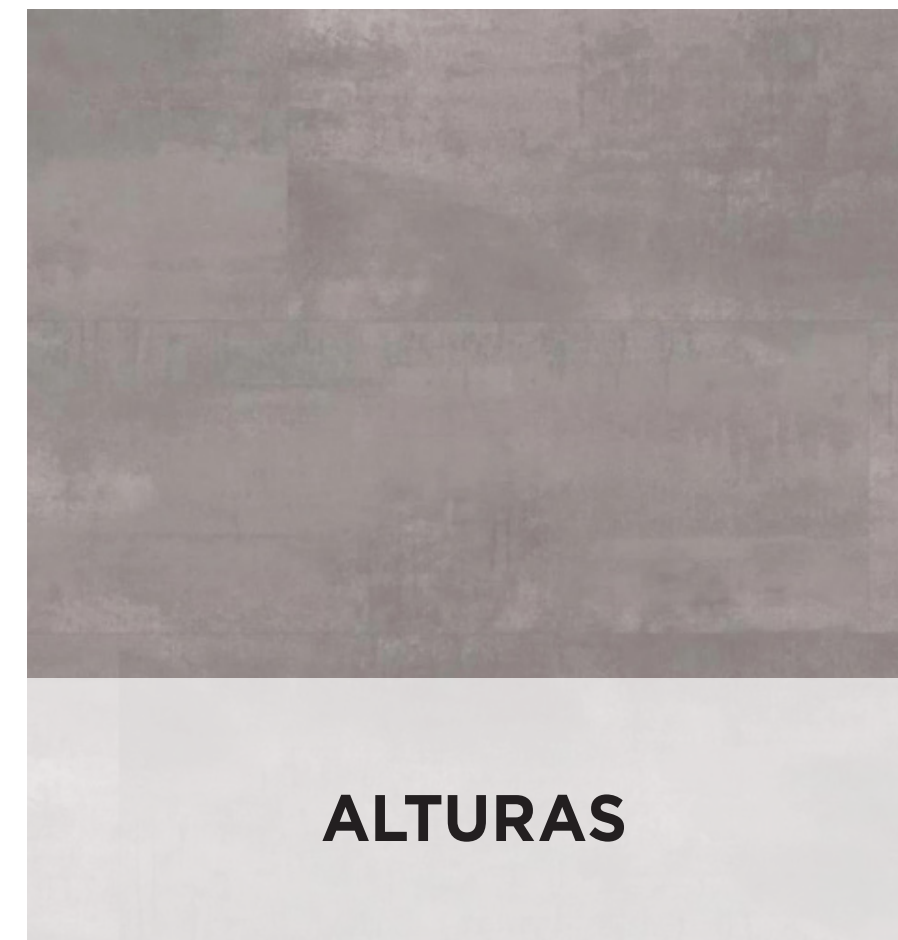

EUROPEAN
MADE

waterwise

TRANSITION MOLDINGS

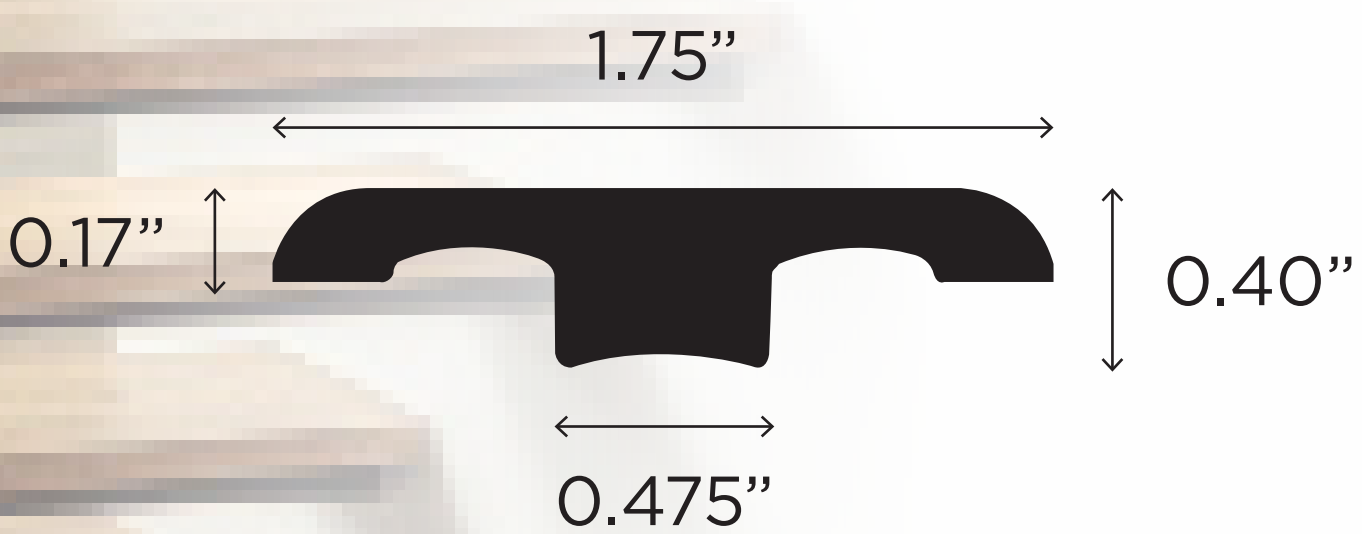

T-MOLDING

Used between floors of equal height.

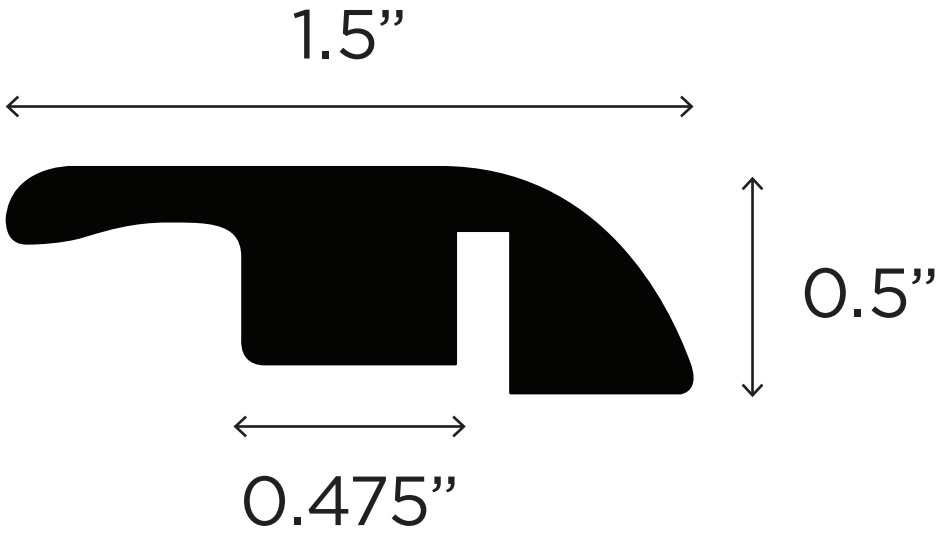

SURFACE REDUCER

Used between floor of unequal height.

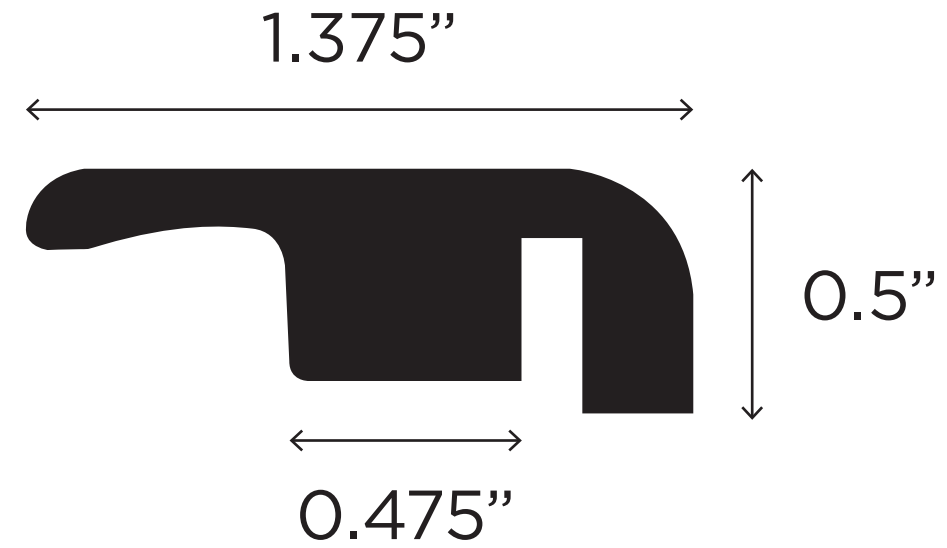

END CAP

Used to fill the gap between the floor and carpet, hearths or against sliding door.

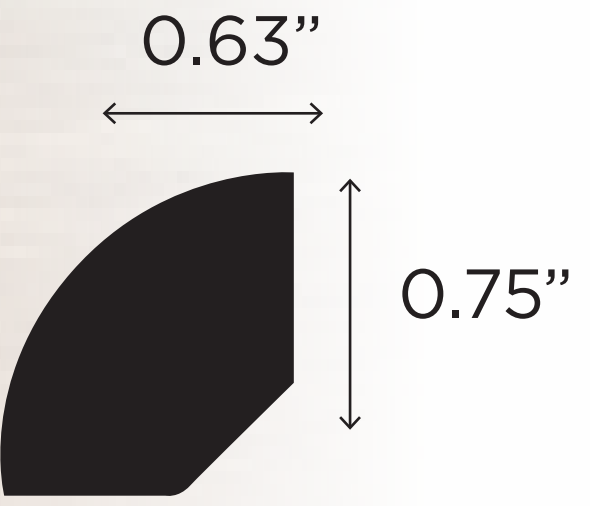

QUARTER ROUND

Covers the gap between the floor and wall.



SQUARE NOSE

Finishes the end of a step.

Square Nose Trim

Elite- 78.75" Length

Premium- 54.5" Length

Select- 54.5" Length

Tile 51" Length

All other trim lengths are 94"

waterwise COMPOSITION

